

COMPLETE
INDUCTION SOLUTIONS

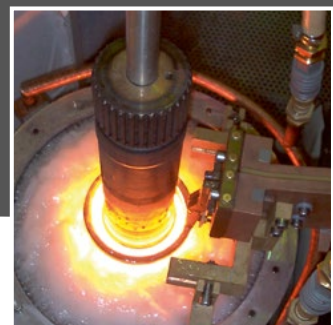

ABOUT US

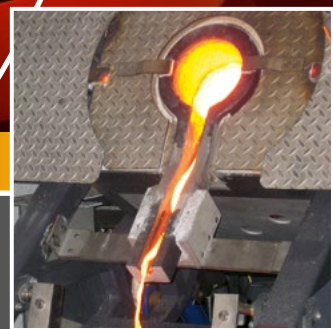
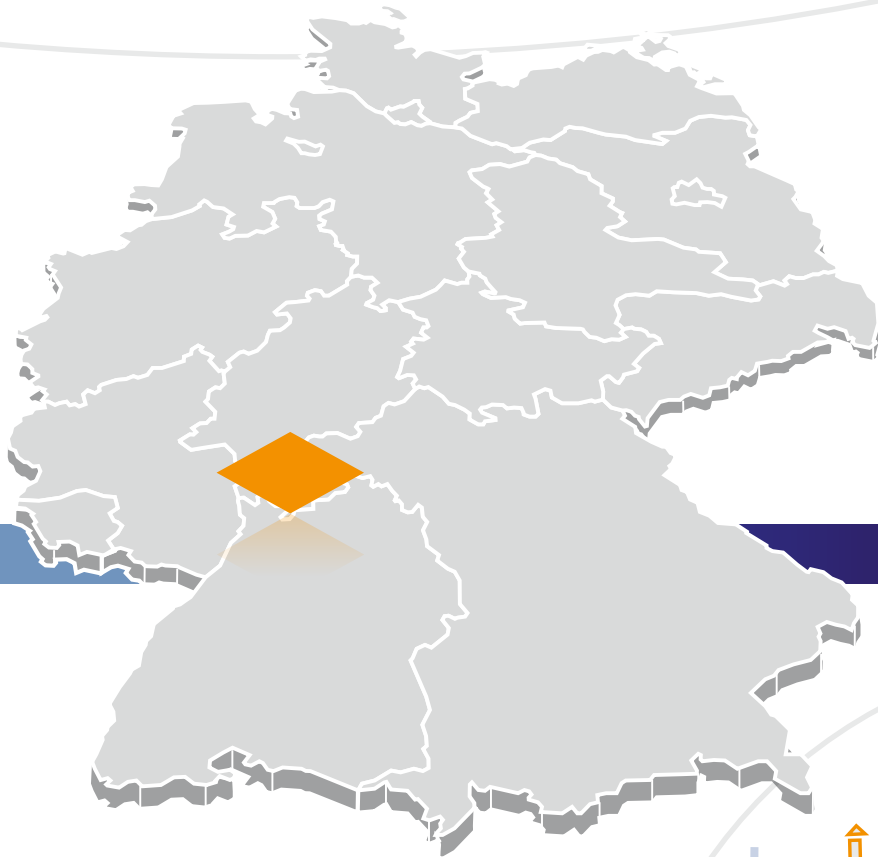

ITG Induktionsanlagen GmbH
Hirschhorn/Neckar

We attend to our customers and partners with approximately 120 employees as well as agencies in Europe and Asia. Our systems are used in the hardening technology and the automobile and supplying industry.

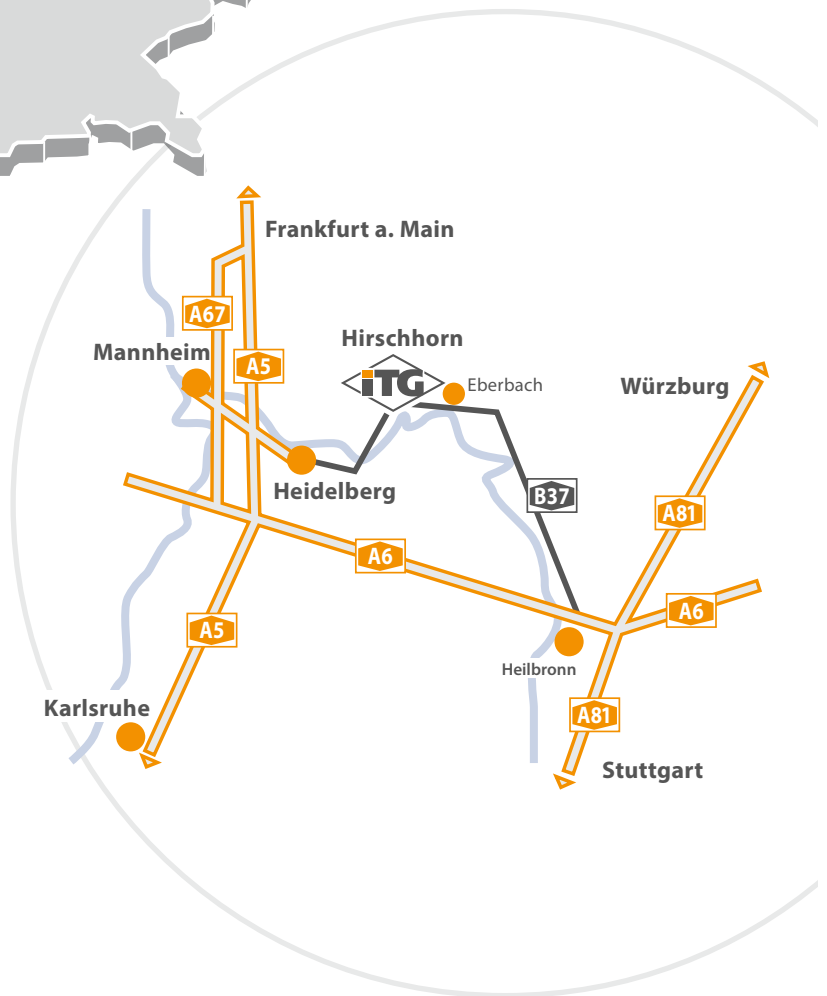



ITG INDUKTIONSANLAGEN GMBH

INDUCTION HEATING SYSTEMS

ITG Induktionsanlagen GmbH is one of the leading manufacturers of induction heating systems. Our core competence lies in specifically converting individual customer requirements into marketable solutions. As part of the SYSTEC group of companies from Karlstadt operating in different sectors, ITG has superior know-how and service at its disposal.

Our innovative strength is the result of long-standing, intensive development processes realised in multiple process- and energy-optimised systems.

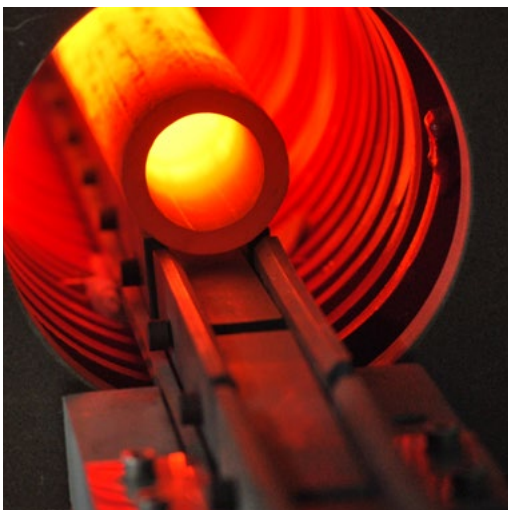

APPLICATIONS – SECTORS

HARDENING

TEMPERING

ANNEALING

FORGING

COATING

MELTING

SMOULDERING

HEATING

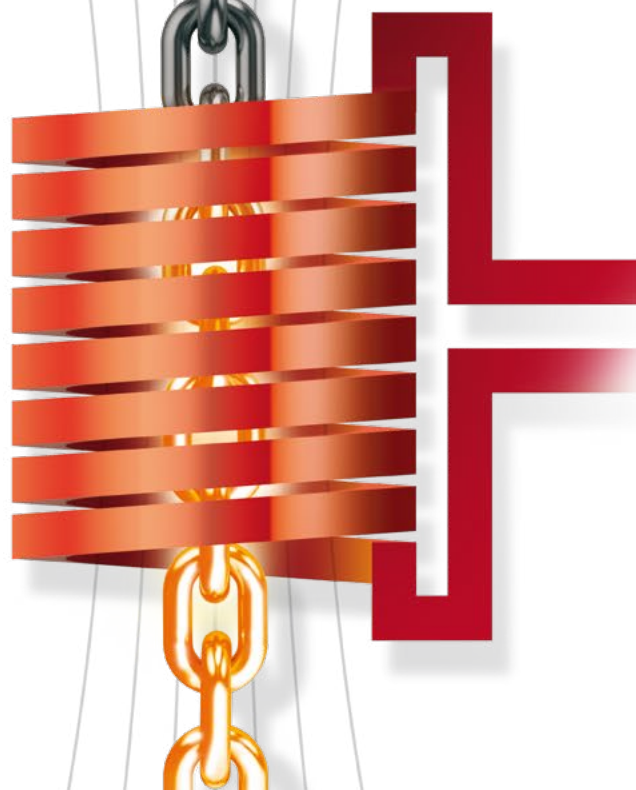

OUR STRENGTH

COMPLETE INDUCTION SOLUTIONS

The overall concept of a system defines its success.

Intensive consultation and close cooperation with our clients is the key to success.

We check the feasibility of the concepts in our own laboratory by means of comprehensive calculations and tests. The concept is then executed precisely as an innovative standard or individual solution. While doing so, we basically aim at sustainability, energy efficiency and optimal efficiency of the systems.

ITG designs and manufactures induction solutions for

- ◆ Research and development
- ◆ Mechanical and plant engineering
- ◆ Steel industry
- ◆ Automotive industry
- ◆ Precious metal processing

ITG heating systems are used in the fields of

- ◆ Raw material extraction
- ◆ Processing of non-ferrous, light, heavy and precious metals
- ◆ Powder production
- ◆ Semiconductor



OUR RANGE OF PRODUCTS

VERSATILE JUST LIKE THE APPLICATIONS

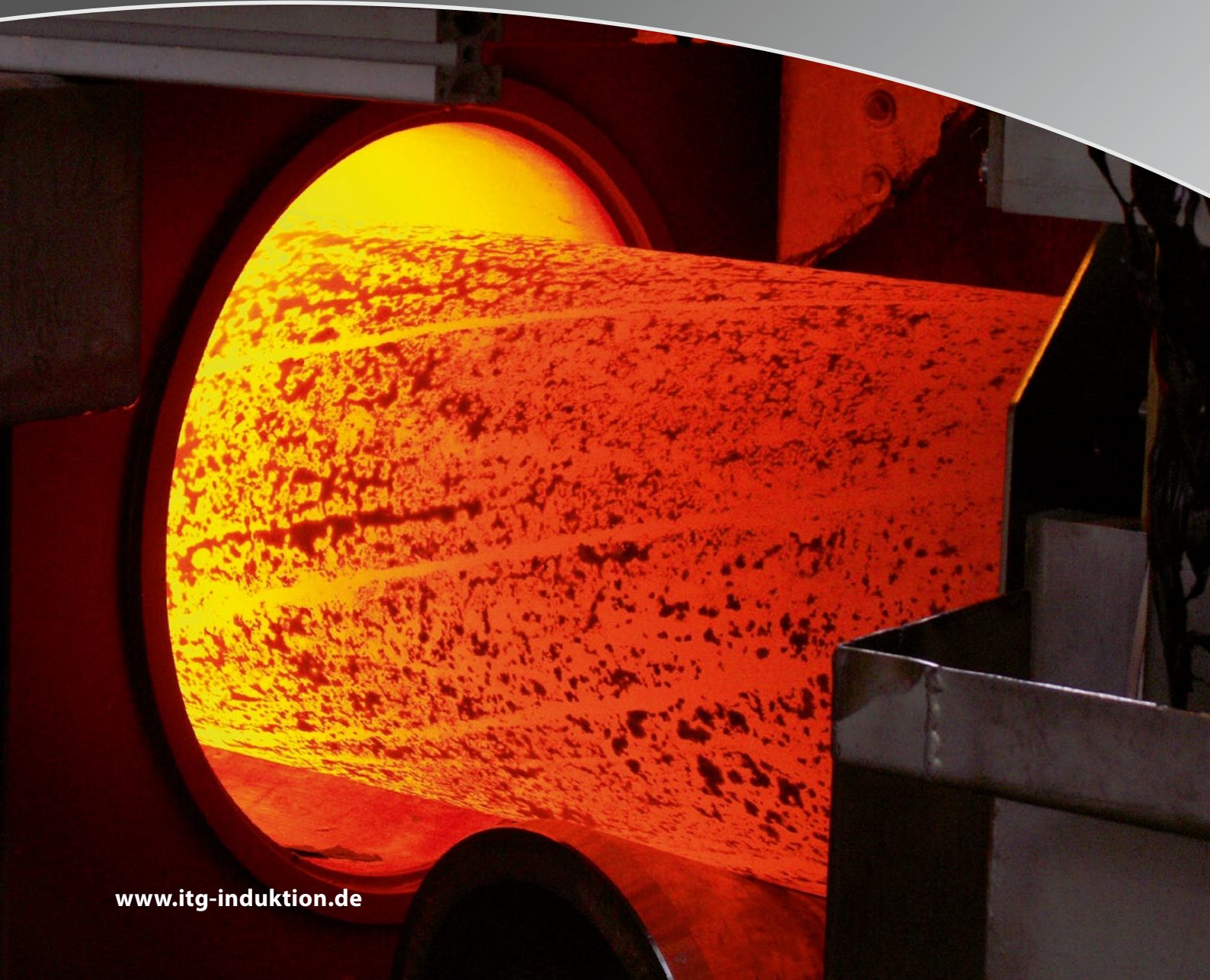

Development and manufacturing of individual induction heating systems

- ◆ Design and realisation of customer-specific solutions in the classic areas of induction heating page 9

Assemblies for induction systems

- ◆ Converters / Generators page 10
- ◆ Inductors / Coils page 11

Hardening, annealing and tempering systems

- ◆ Chain hardening systems page 13
- ◆ Vertical hardening machines page 14
- ◆ Surface hardening lines page 15
- ◆ Pipe hardening systems page 16
- ◆ Inductive single bar quench & temper systems page 17

Induction systems for thermal metal processing

- ◆ Wire and band heating systems page 19
- ◆ Forging systems page 20
- ◆ Melting systems page 21

Service - After Sales

- ◆ Repair – Service – Training page 23
- ◆ Sale of spare parts page 23

COMPONENTS INDIVIDUALLY CONFIGURED

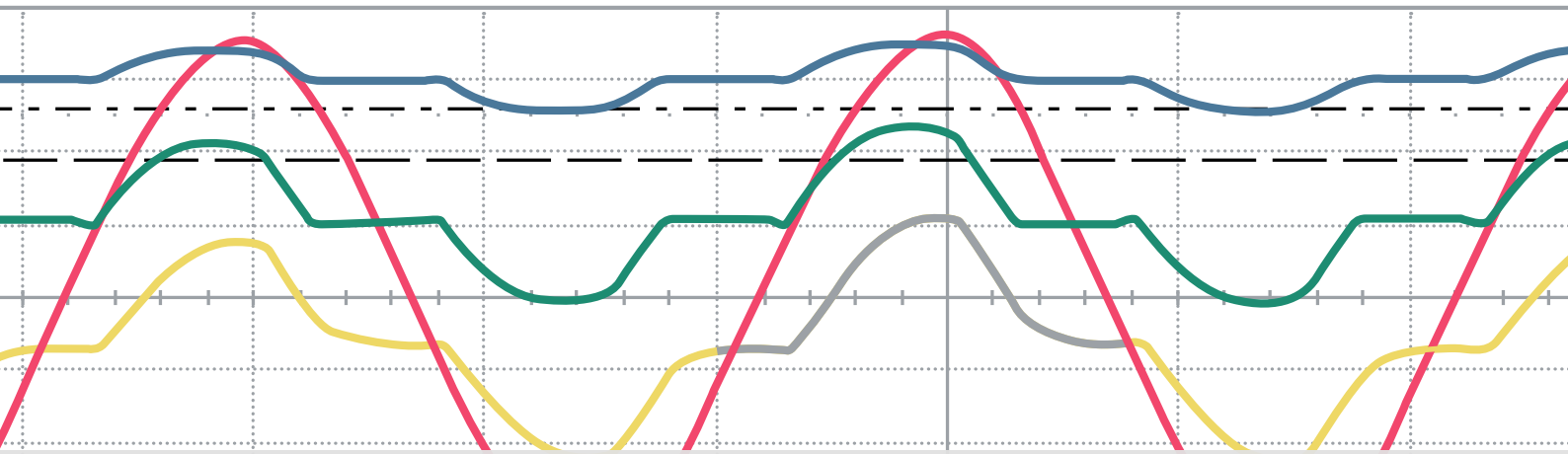

The key components converter and coil are developed, planned and manufactured in-house.

Converters / Generators

Inductors / Coils

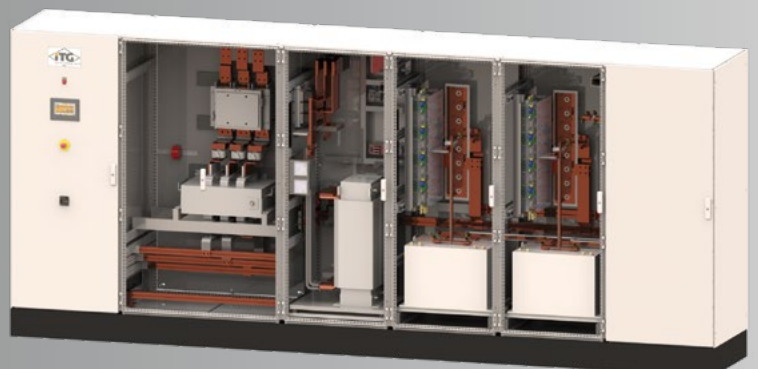
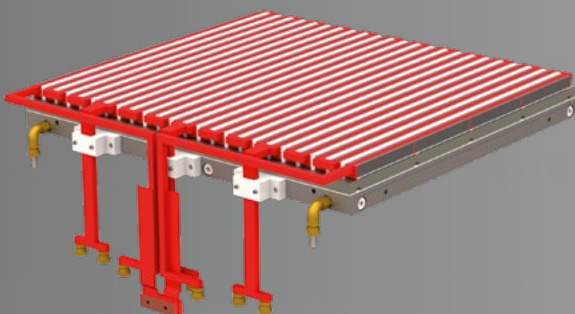
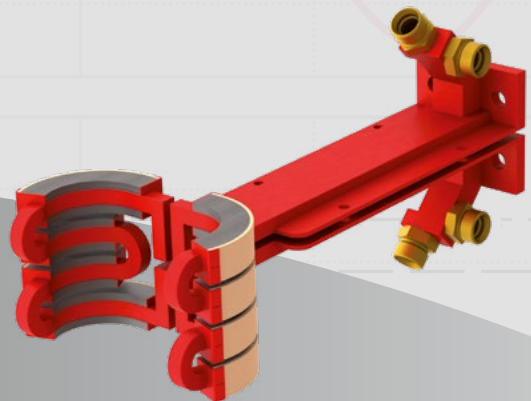

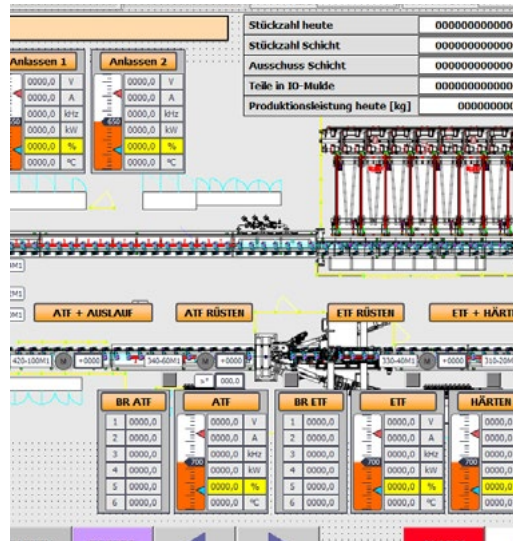

Our aspiration is responsible use of resources and the related challenge of manufacturing modern, energy-efficient systems for producing high-strength components.

Our longstanding experience and the integration into the SYSTEC group of companies have made us one of the leading manufacturers of induction heating systems. With 110 employees as well as agencies in Europe, Asia and South America, our customers and business partners always have competent experts at their disposal.

ITG Induktionsanlagen – complete solutions under one roof

- ◆ Process development and research
- ◆ Consultation and planning

Our customers are from the field of hardening technology and the automobile and supplying industry.

In research and development, we work in close cooperation with industrial partners and universities.

ITG systems are used in foundries and melting shops for precious metals, in the metal processing industry as well as by pipe, bar steel and wire manufacturers.

- ◆ Designing and production
- ◆ Project management
- ◆ Installation and commissioning
- ◆ Maintenance, service and training

FREQUENCY CONVERTERS / GENERATORS

The heart of every induction system is the individually adapted frequency converter. Our range for the most varied applications stretches from 50 Hz to 1000 kHz with powers ranging between 2 kW and several megawatts.

Transistorised high-frequency generator ITH

The high-frequency generator is built up in MosFet technology. It facilitates working frequencies of 100 to 1000 kHz, depending on the power at the inductor terminals. In case of tabletop units, this is 2 to 20 kW, while more powerful units up to several hundred kW can be manufactured in cabinet design.



Compact converter ITPC

The medium-frequency converter is built up with compact components in IGBT technology. Working frequencies of 6 to 100 kHz can be attained here with a power of up to 25 kW in a tabletop version and up to 50 kW in a cabinet design.



Transistorised medium-frequency converter ITPA

The medium-frequency converter is equipped with the IGBT technology, which allows for working frequencies of 50 Hz to 100 kHz and up to several megawatts. With a special synchronising unit, multiple converters can be operated at one load. Their power can be controlled individually independent from each other. Thus, different temperature zones can be realised on one workpiece.



INDUCTORS / COILS

The inductor or the coil is virtually the tool for the induction heating. The power transfer and thus the heating of the workpiece take place through the inductor. It consists of a water-cooled copper pipe, the shape of which is especially adjusted to the heating task.

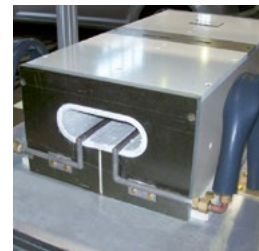
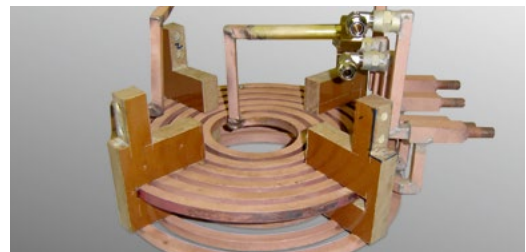
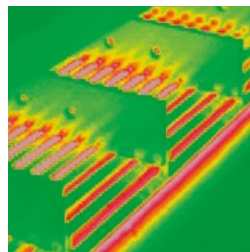
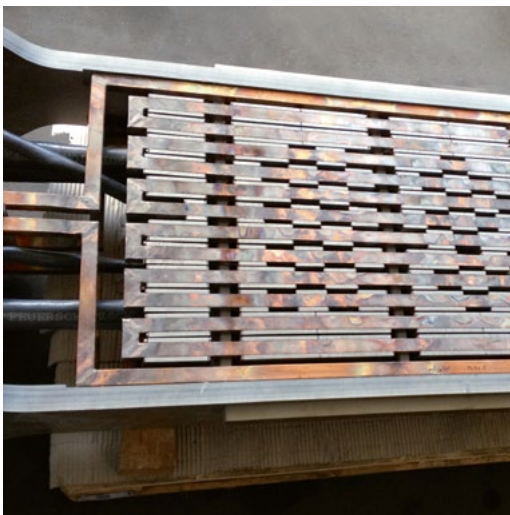

We design the inductor according to the customer's requirements and manufacture it in our own workshop; repairs are also carried out professionally in our plant.

Abilities

- + Tool of the induction
- + Inductors and coils adapted to the application
- + Contact-less transfer of energy

Key-Benefits

- + In-house development and manufacturing
- + In-house repairs

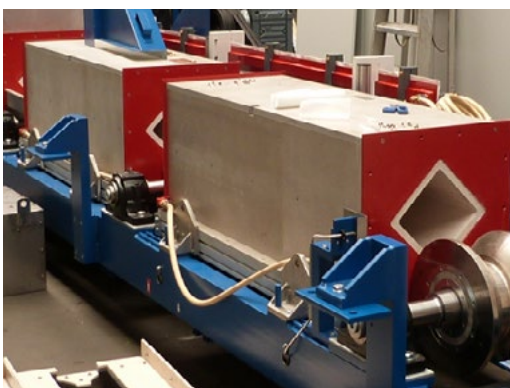

HARDENING, ANNEALING, TEMPERING FOR INDIVIDUAL APPLICATIONS



The properties of the raw materials are changed with our systems. The customer specifies which properties the workpiece should attain; the induction system is designed accordingly. Thanks to a defined power transfer to the components, entire batches of components can be heat-treated with repeat accuracy.

Chain hardening systems

Vertical hardening machines

Surface hardening lines

Pipe hardening systems

Inductive single bar quench & temper systems

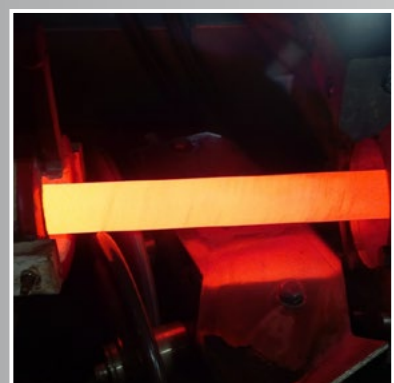
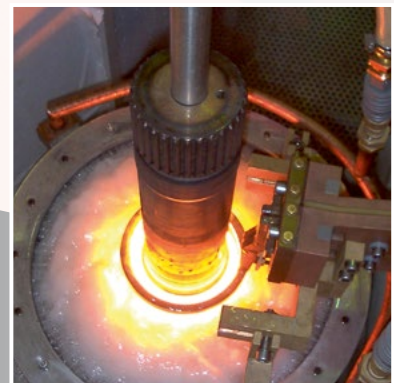

CHAIN HARDENING SYSTEMS

The requirement for chains for lifting gears or for the mining industry is increasing continuously. Heat treatment helps make the chains more wear-resistant and more stable with the same cross-sections.

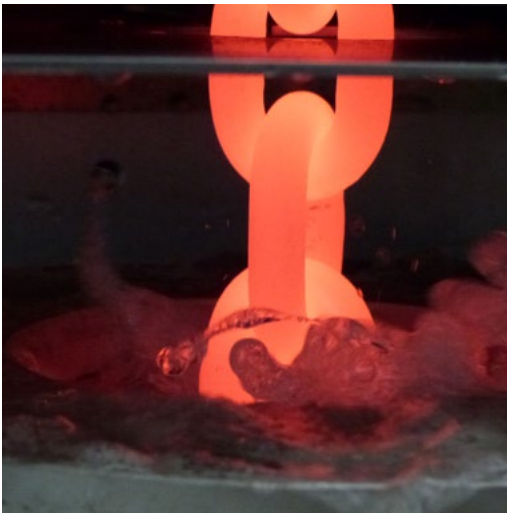

Hardening temperatures of up to 1,000°C, freely configurable annealing temperatures and the option of partial quenching offer the customer maximum flexibility with a single system.

The chains can thus be realised in a standard-conform design with homogeneous hardness over the entire cross-section as well as quenched partially with different hardnesses.

Basic data

- + Completed systems for chains of $\varnothing 6 - \varnothing 48$ mm
- + Hardening, annealing and partial annealing in one cycle
- + Continuous process monitoring

Key-Benefits

- + Homogeneous annealing through equalising section
- + User-friendly coil change by sliding
- + Monitoring and documentation of all relevant process parameters



VERTICAL HARDENING MACHINES

The new generation of the ITG hardening machines combines state-of-the-art technology with extremely compact design to offer optimal ease of maintenance.



Besides the freely programmable Siemens control system, the basic configuration includes two re-cooling units for cooling water and emulsion as well as the required converter for power generation (including transformer or oscillating circuit).

This innovative new development is very convincing thanks to its efficiency and cost-effectiveness. It is characterised by e.g. true-contoured hardening, reproducible hardening results as well as continuous quality control with consistent process monitoring and documentation.

Basic data standard system

- + Workpiece length of up to 2,000 mm
- + Workpiece diameter of up to 250 mm
- + Workpiece weight of up to 250 kg
- + Special designs are possible

Key-Benefits

- + Complete system in compact design
- + Easy-to-operate system thanks to simple, menu-driven control
- + Large bandwidth of power and frequency for an optimal hardening result

SURFACE HARDENING LINES

Continuous heat treatment platform for a wide range of dimensions and penetration depths.

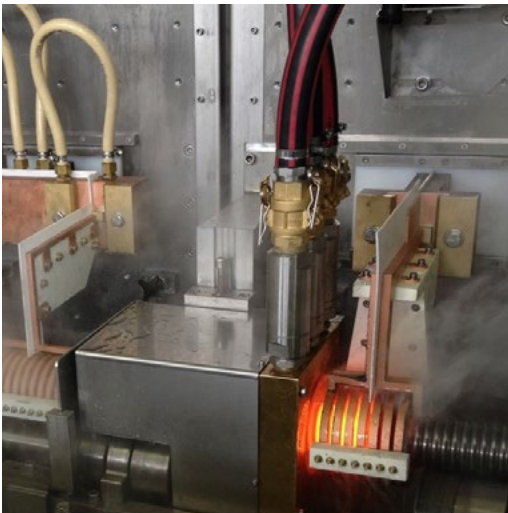

Heat treatment processes of the surface layer as base material for complex components in the automotive sector require an outstanding process data management. Close tolerance ranges of quality assurance are reproducibly ensured by appropriate control hard- and software.

Rahmendaten

- + Continuous heat treatment platform for a wide range of dimensions and penetration depths**
- + Surface layer hardening with subsequent tempering**
- + Ideal for bright steel products due to minimal distortion**

Key-Benefits

- + Frequency switching assures variation of the penetration depth**
- + Reproducible processes ensure reproducible product quality**
- + Energy-efficient due to optimized matching transformers**
- + Double disk drive concept offers superior heating and quenching results**
- + Process data control and archiving for CQI-9 requirements**
- + Comprehensive option catalogue for customized adaptation**
- + Quick changeover and tooling**



PIPE HARDENING SYSTEMS

Heat treatment of pipes facilitates expanding the applicability of pipes and saving material as well as reducing weight.



The combined hardening and annealing system for pipes can be designed as an inline system or in U shape depending on the available space. Different coil sets adapted to the pipe diameter allow for a wide range of pipe diameters.

Basic data

- ⊕ Completed systems for pipe diameters of up to 450 mm
- ⊕ Hardening and annealing in one cycle; recrystallisation annealing is possible
- ⊕ Completed systems for a performance of up to 7 t/h

Key-Benefits

- ⊕ Constant quality thanks to a high performance and thus, fast heating and cooling
- ⊕ Short set-up times thanks to user-friendly reorganisation of coils
- ⊕ Automatic setting of process parameters

INDUCTIVE SINGLE BAR QUENCH & TEMPER SYSTEMS

The challenge in heat treatment of long products is to achieve low distortion and reproducible processes.

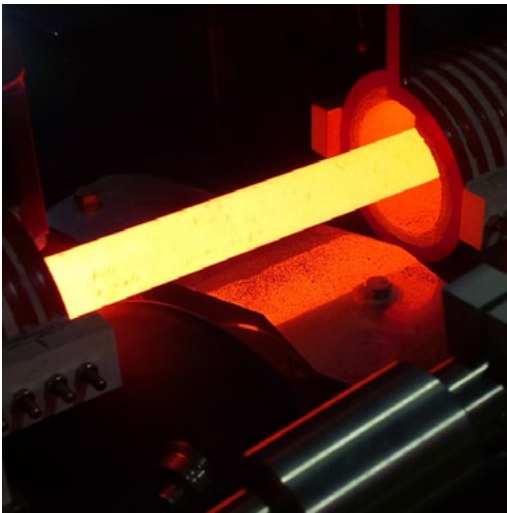

The complex interplay of the transport unit, induction heating and chilling sprinklers speaks for this one-stop solution.

The continuously changing requirements of the different areas of application always give us new guidelines for consistent optimisation of our systems.

Basic data

- + Heat treatment platform for a wide range of dimensions of solid material (bright steel, rolled steel) and tubes
- + Hardening, annealing, soaking and other heat treatment processes within a cycle
- + Continuous process monitoring and logging

Key-Benefits

- + Customized plant and process design
- + Excellent homogeneity for quality right down to the core
- + Quality assurance systems to the state of the art
- + Reproducible processes ensure reproducible product quality
- + Energy-efficient production with low maintenance and servicing requirements
- + Various drive concepts for optimized adaptation to the product range
- + Comprehensive option catalogue for customized adaptation
- + Quick changeover and tooling



METAL PROCESSING

HIGHLY EFFICIENT AND PRECISE



One of the areas of application of induction systems is the processing of metals, which can then be shaped (cast) or reshaped.

Wire and band heating systems

Forging systems

Melting systems



WIRE AND BAND HEATING SYSTEMS

The production of conductors, brake pipes, high-voltage cables, bridge bracing wires, car spring wires, etc. requires continuous heating. If the work pieces are transported in the continuous process via up and down coilers in the process line, then induction heating can be integrated without any problems.

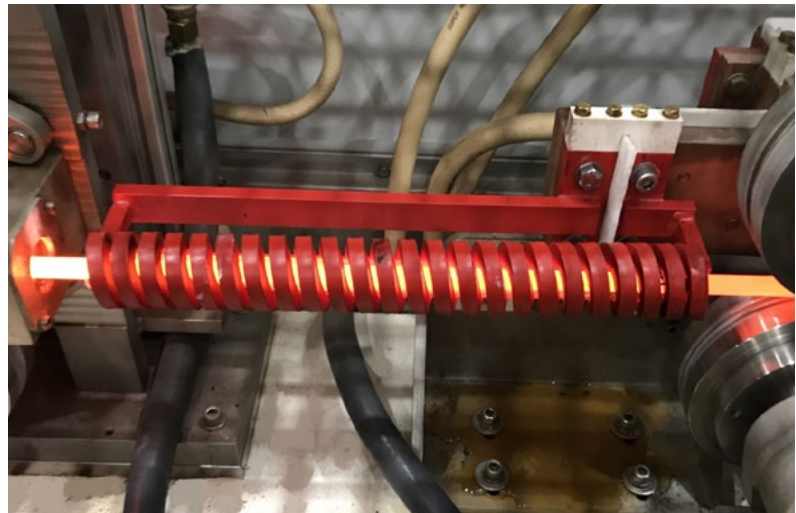
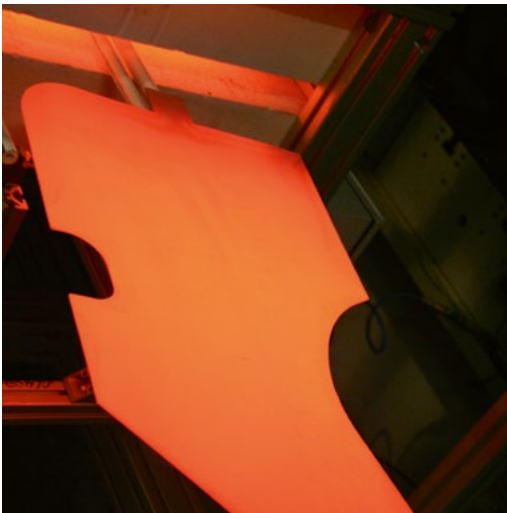

Manifold processes can be realised thanks to the easily adjustable process parameters of an induction system. Wires and bands are dried at lower temperatures. Wires and bands are coated or the raw material properties are set specifically at higher temperatures.

Skin layer heating or through heating of components can be realised depending on the requirement. Only little space is required for the heating thanks to the high energy density of an induction system.

Basic data

- + Sheets with a thickness of 0.8 mm and above
- + Wires with a diameter of 0.9 mm and above
- + Multiple parallel strands are possible

Key-Benefits

- + Short heating sections
- + Skin layer heating or through heating is possible
- + Speed-dependent power control is possible



FORGING SYSTEMS

In order to reshape components, it is often necessary to heat them.
An induction system facilitates energy- and time-efficient repetitive operations.

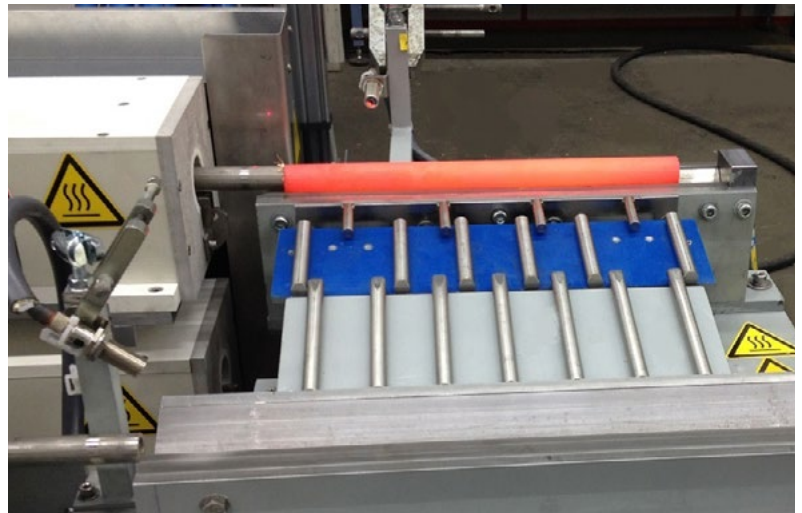
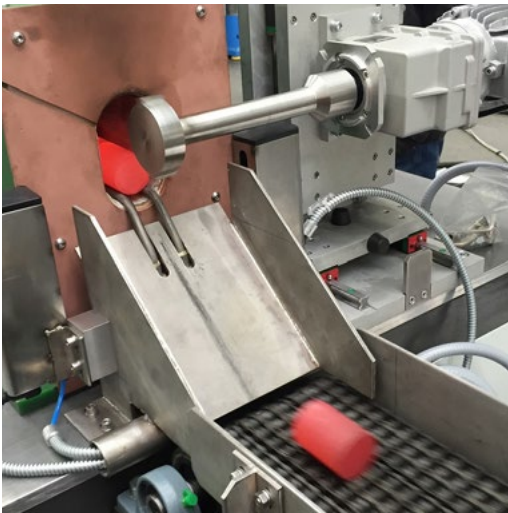

The advantage of induction forging is that the component can be heated completely or partially.

Basic data

- + Manual or automatic loading
- + Push-through transport systems as well as transport systems with lifting bars or chains are possible
- + Temperature regulation possible in case of stationary heating

Key-Benefits

- + Quick, efficient heating
- + Reproducible results
- + Partial heating is possible

MELTING SYSTEMS

A nearly unlimited variety of shapes can be created from molten metal.

Induction melting systems facilitate very high temperatures so that even platinum alloys can be melted.

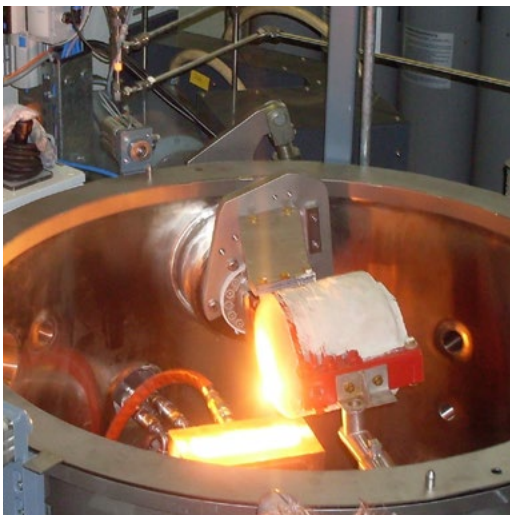

Predominantly metals are melted using induction melting systems. The variety of materials ranges from light metals, steel and heavy metals, up to precious metals.

Based on the required batch size, we offer different types of melting furnaces – adapted to the respective application.

Basic data

- + Manually tiltable melting furnace for batches of up to 5 kg
- + Push-out melting furnace for batches of up to 30 kg
- + Electrically tiltable melting furnace for batches of up to 150 kg
- + Hydraulically tiltable melting furnace for batches of up to 1,000 kg
- + Vacuum melting systems

Key-Benefits

- + Industrial design
- + Different crucible materials are possible



Detailed information available online at www.itg-induktion.de

SERVICE – AFTER SALES

SAFE IN THE BEST HANDS

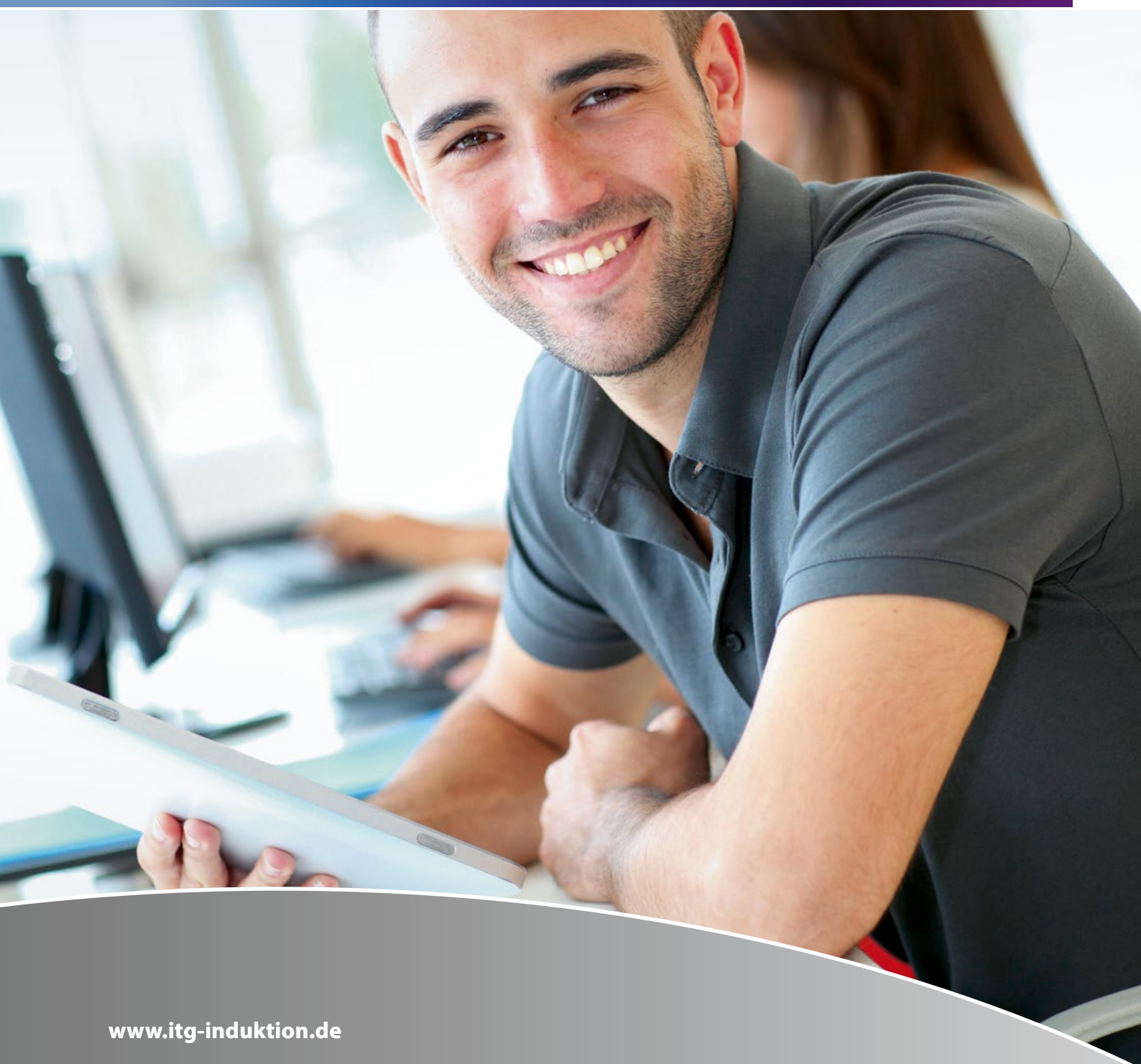

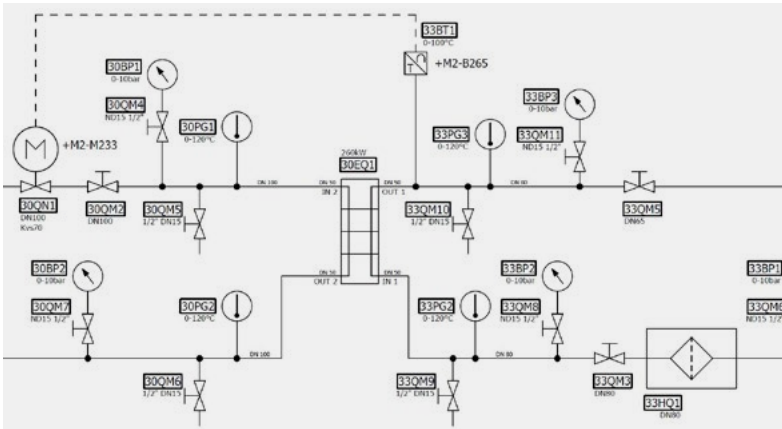

**ITG Induktionsanlagen –
Safe in the best hands**

- ◆ Worldwide service
- ◆ Rental and used converters
- ◆ Experienced and highly-qualified service technicians
- ◆ Commissioning, maintenance, repair, service and training
- ◆ Worldwide delivery of spare parts
- ◆ Professional advice with regard to energy efficiency, cooling water management and work safety

Maintenance / Repair / Service / Training

Our service does not end with the commissioning of a new system. A team of competent experts will be happy to help you with any technical questions about your system. Our employees are your contact persons for consultations, execution of repairs, maintenance, alterations, adjustments of machines, etc. and also for problems of other manufacturers.

Sale of spare parts

Required components can normally be manufactured at short notice or procured. We deliver worldwide. We are thereby supported by our agencies abroad.

In-house hardening

On request, hardening processes can also be carried out in our systems.

Energy efficiency and cooling water management

Our experts advise you on current topics of energy efficiency and cooling water management. The improvements of converter technology focussed on the power components in order to meet the global requirements concerning „Green Economy“. In this context, a smart cooling water management was developed to potentially cut cooling water consumption in half. In addition to the induction components, the individually adapted cooling water systems round off the product portfolio into solution from a single source.

Rental and used converters

Whether for testing a process, as an interim solution or in the event of a failure, a wide range of converters and additional equipment are available for rental, depending on availability. Outputs up to 1.500 kW and frequencies from 0.5 kHz to 350 kHz can be realized.

 Scan the code
for detailed
information



Quality 
Made in Germany

ITG Induktionsanlagen GmbH • Neckarsteinacher Straße 88 • 69434 Hirschhorn/Neckar • Germany
phone +49 6272 9203-0 • fax +49 6272 9203-10 • zentrale@itg-induktion.de

www.itg-induktion.de

SYSTEC
GRUPPE

The information provided in this documentation contains general descriptions and/or technical characteristics of the performance of the products contained herein. This documentation is not intended as a substitute for and is not to be used for determining suitability or reliability of these products for specific user applications. All specifications without guarantee, errors and omissions expected, subject to changes. © 2020 ITG Induktionsanlagen GmbH